



ARKO

WALL PROTECTIONS



LM MEDICAL
DIVISION

LM MEDICAL DIVISION

Founded by the Lancini family, LM MEDICAL DIVISION is the thriving result of more than 30 years of expertise in the industrial power units and electromedical equipment. The recently born international brand, specialized in medical supply units for foreign countries, has been witnessing an unrestrained growth especially over the past recent years.



We are a full-service supplier in electromedical equipment, privacy solutions and wall protections. We offer full assistance, thoughtful planning, step-by-step development, efficient production and installation, careful maintenance and reliable servicing.

Attention to detail together with our unceasing search for up-to-date functioning design embraces a remarkable technical know-how; this winning attitude has allowed us to develop high-quality equipment for the various functions needed in the modern healthcare.

Our headquarters host all departments, from designing and technical planning to all main production processes. We strongly believe that in order to offer an accurate customizable product, project development and all further steps in the supply chain need the most attentive and close monitoring. This is also the only way we can guarantee that each part matches perfectly and we can step in to make on-the-spot corrections if needed.



All LM MEDICAL DIVISION products are made exclusively in Italy and all semifinished products and components in supply are solely of Italian or German output. We only use the very best materials and technologies in our manufacturing as quality represents for us a binding commitment to all our customers.

Putting quality into the foreground means for us to enrich our company with an extremely skilled and dutiful staff striving for customer's complete satisfaction. Choosing LM MEDICAL DIVISION means to have a trained team capable to achieve the most ambitious projects, customizable to the very smallest detail.

What is making our company unquestionably up to the very best international standards is the tangible capability to tailor offerings to our customers. From technical layouts to finishing touches everything can be adapted and installed according to whichever request.





FULL PRODUCTS' RANGE OF BUMPERS, CORNER GUARDS, HAND RAILS AND WALL COVERINGS.

These products are 100% made in Italy.

The high technology and the detailed refined product design offer to architects and builders the best solution and integration into all medical environments, hospitals, medical clinics and rehabilitation centers.



CGL - CORNER GUARDS

PG - 5



CG.55 / 75 - CORNER GUARDS

PG - 6

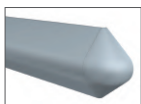

B.110 - BUMPERS

PG - 7

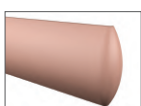

B.125 - BUMPERS

PG - 8

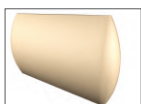

B.200 - BUMPERS

PG - 9

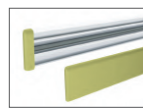

P.200 - BUMPERS

PG - 10



HL.40 - HANDRAILS

PG - 11

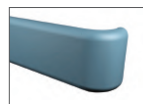

BH.140 - BUMPER HANDRAILS

PG - 12

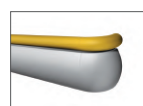

BH.170 - BUMPER HANDRAILS

PG - 13



HC.250 - CRASH RAILS

PG - 14



EUROPEAN FIRE RATING: B-S2 / D0
NON TOXIC FUMES
FIRE RETARDANT
ANTIMICROBIAL CERTIFIED
ECOLOGIC AND RECYCLABLE
CHEMICALS RESISTANT
UV RAYS STABILITY
TEST FOR HIGH-IMPACT PERFORMANCE
EASY CLEANED



SK.100 - SKIRTINGS

PG - 15

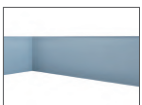

SH - WALL COVERINGS

PG - 16

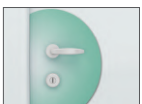

DH - PROTECTION FOR DOOR HANDLES

PG - 17

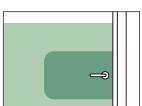

DC - DOOR COVERINGS

PG - 18



PHOTOGALLERY

PG - 19 > 20



COLOURS

PG - 21



CERTIFICATIONS

PG - 22

CGL CORNER GUARDS

Supply and installation of shock-absorbing profile for edge corners newly developed with non-toxic, antibacterial materials and a wingspan ranging from 25 to 100 mm.

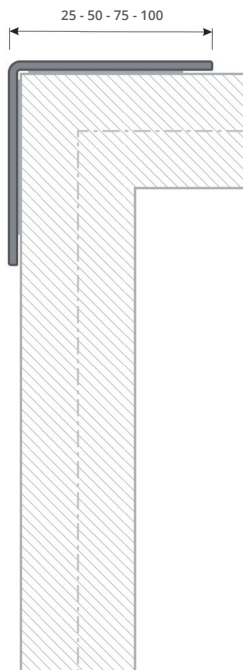

ITEM SPECIFICATIONS

Profile	A 25-50-75-100 mm wide shock-resistant wingspan corner bead in our newly developed PVC FREE POLYCARBONATE profile. Certified European EN 13823 and EN ISO 11925-2 "B-s2,d0" antibacterial certification for Medical usage, with a thickness of 2mm.
Finishing	A matte finish with fine embossing for a perfect sanitary protection.
Colours	Pigments not containing cadmium and heavy metals, chlorine, phthalates, bromide, halogens and antimony are amalgamated with the main plastic raw substance.
Mounting	Mounted on the wall with suitable glue allowing tight seal.
Certifications	European Certification EN 13823 and EN ISO 11925-2 "B-s2,d0" and antibacterial certification for medical usage.



CG.55 - CG.75 CORNER GUARDS

Supply and installation of shock-absorbing corner guards newly developed with non-toxic, antibacterial materials and 55 mm or 75 mm wingspan.

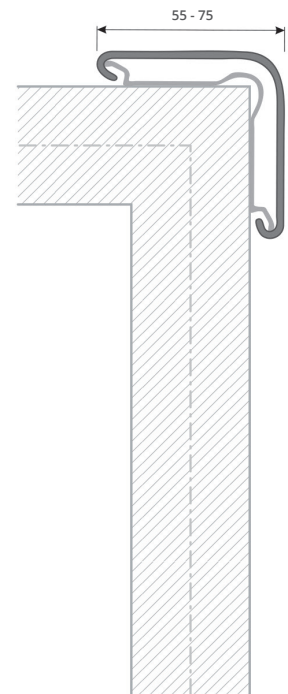

ITEM SPECIFICATIONS

Profile	A 55-75 mm wide shock-resistant wingspan corner bead, in our newly developed PVC FREE POLYCARBONATE profile. Certified European EN 13823 and EN ISO 11925-2 "b-s2,d0" antibacterial certification for Medical usage, with a thickness of 2mm.
Finishing	A matte finish with fine embossing for a perfect sanitary protection.
Colours	Pigments not containing cadmium and heavy metals, chlorine, phthalates, bromide, halogens and antimony are amalgamated with the main plastic raw substance.
Mounting	Wall mounted, snap up, on an inflexible extruded aluminum profile; fastened with anchor bolts for a tight seal it is also suitable for double plasterboard walls with lag screws instead.
End caps	Slotted in the main support to allow perfect fit, in the same plastic material of the profile.
Certifications	European Certification EN 13823 and EN ISO 11925-2 "B-s2,d0" and antibacterial certification for medical usage.

B.110 BUMPERS

Supply and installation of elliptical, shock-absorbing bumpers newly developed with non-toxic antibacterial plastic materials of 110 mm maximum height.

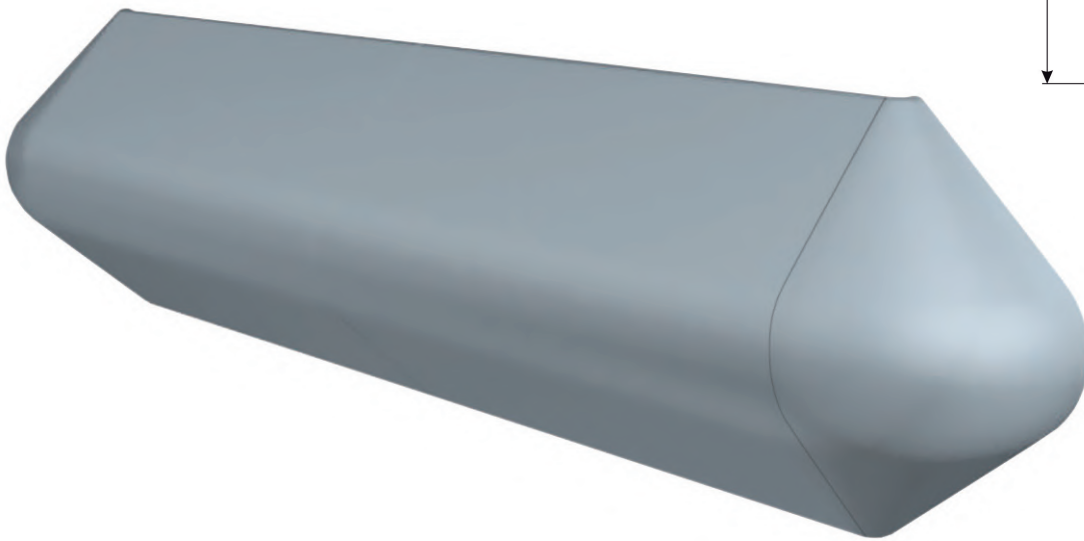
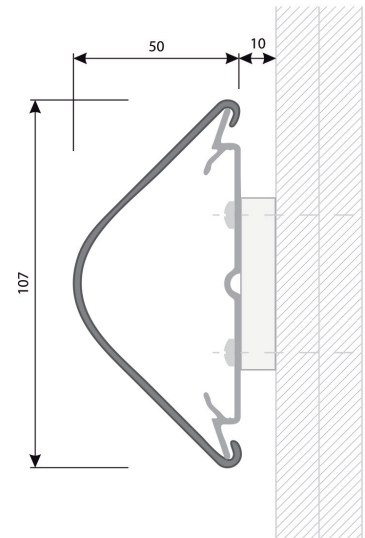

ITEM SPECIFICATIONS

Profile	Elliptical shaped and shock-absorbing in our newly developed PVC FREE POLYCARBONATE profile. Certified European EN 13823 and EN ISO 11925-2 "b-s2,d0" antibacterial certification for Medical usage, with a thickness of 2mm.
Finishing	A matte finish with fine embossing for a perfect sanitary protection.
Colours	Pigments not containing cadmium and heavy metals, chlorine, phthalates, bromide, halogens and antimony are amalgamated with the main plastic raw substance.
Mounting	Wall mounted, snap up, on an inflexible and seamless extruded aluminum profile; fastened with anchor bolts for a tight seal it is also suitable for double plasterboard walls with lag screws instead.
End caps	Slotted in the main support to allow perfect fit, in the same plastic material of the profile.
Certifications	European Certification EN 13823 and EN ISO 11925-2 "B-s2,d0" and antibacterial certification for medical usage.

B.125 BUMPERS

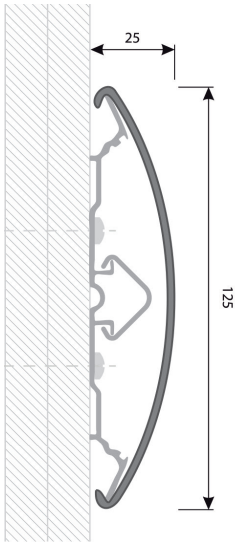

Supply and installation of elliptical, shock-absorbing bumpers newly developed with non-toxic antibacterial plastic materials of 125 mm maximum height.

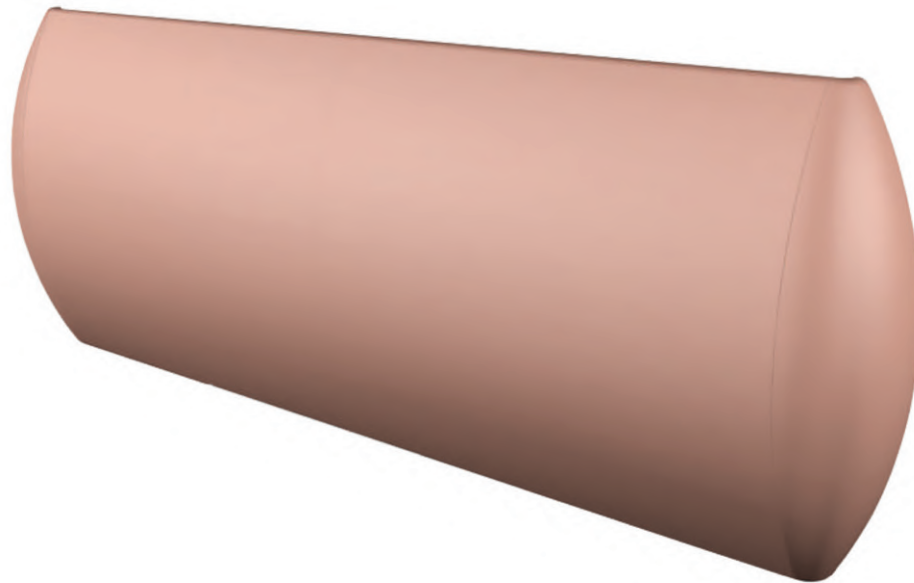

ITEM SPECIFICATIONS

Profile	Elliptical shaped and shock-absorbing in our newly developed PVC FREE POLYCARBONATE profile. Certified European EN 13823 and EN ISO 11925-2 "b-s2,d0" antibacterial certification for Medical usage, with a thickness of 2mm.
Finishing	A matte finish with fine embossing for a perfect sanitary protection.
Colours	Pigments not containing cadmium and heavy metals, chlorine, phthalates, bromide, halogens and antimony are amalgamated with the main plastic raw substance.
Mounting	Wall mounted, snap up, on an inflexible and seamless extruded aluminum profile; fastened with anchor bolts for a tight seal it is also suitable for double plasterboard walls with lag screws instead.
End caps	Slotted in the main support to allow perfect fit, in the same plastic material of the profile.
Certifications	European Certification EN 13823 and EN ISO 11925-2 "B-s2,d0" and antibacterial certification for medical usage.

B.200 BUMPERS

Supply and installation of elliptical, shock-absorbing bumpers newly developed with non-toxic antibacterial plastic materials of 200 mm maximum height .

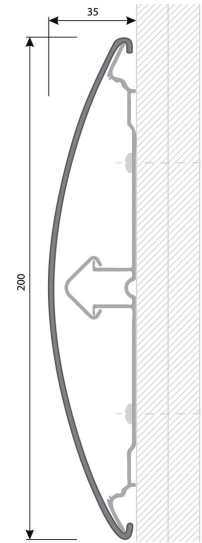

ITEM SPECIFICATIONS

Profile	Elliptical shaped and shock-absorbing in our newly developed PVC FREE POLYCARBONATE profile. Certified European EN 13823 and EN ISO 11925-2 "b-s2,d0" antibacterial certification for Medical usage, with a thickness of 2mm.
Finishing	A matte finish with fine embossing for a perfect sanitary protection.
Colours	Pigments not containing cadmium and heavy metals, chlorine, phthalates, bromide, halogens and antimony are amalgamated with the main plastic raw substance.
Mounting	Wall mounted, snap up, on an inflexible and seamless extruded aluminum profile; fastened with anchor bolts for a tight seal it is also suitable for double plasterboard walls with lag screws instead.
End caps	Slotted in the main support to allow perfect fit, in the same plastic material of the profile.
Certifications	European Certification EN 13823 and EN ISO 11925-2 "B-s2,d0" and antibacterial certification for medical usage.

P.200 BUMPERS

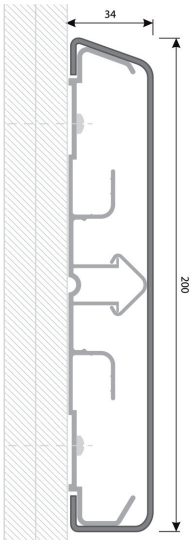

Supply and installation of a rectangular shock-absorbing bumper newly developed with non-toxic, antibacterial plastic materials of a 200 mm maximum height .

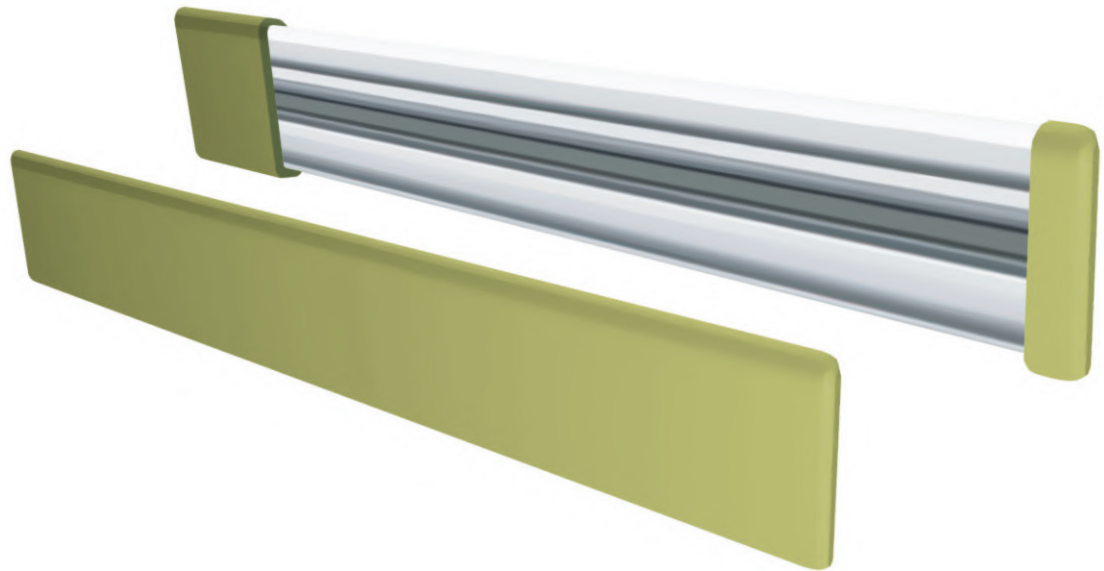

ITEM SPECIFICATIONS

Profile	200 mm high and shock-absorbing rectangular structure in our newly developed PVC FREE POLYCARBONATE profile. Certified European EN 13823 and EN ISO 11925-2 "b-s2,d0" antibacterial certification for Medical usage, with a thickness of 2mm.
Finishing	A matte finish with fine embossing for a perfect sanitary protection.
Colours	Pigments not containing cadmium and heavy metals, chlorine, phthalates, bromide, halogens and antimony are amalgamated with the main plastic raw substance.
Mounting	Wall mounted, snap up, on an inflexible and seamless extruded aluminum profile; fastened with anchor bolts for a tight seal it is also suitable for double plasterboard walls with lag screws instead.
End caps	Internal and external ones slotted in the main support to allow perfect fit, in the same plastic material of the profile.
Certifications	European Certification EN 13823 and EN ISO 11925-2 "B-s2,d0" and antibacterial certification for medical usage.

HL.40 HANDRAILS



Supply and installation of a tubular 40 mm handrail newly developed with non-toxic, antibacterial plastic materials.

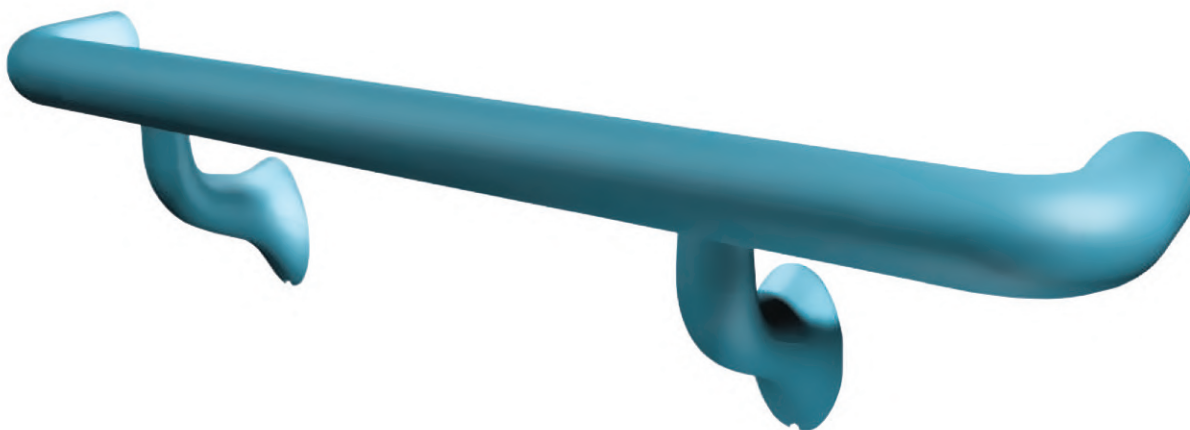
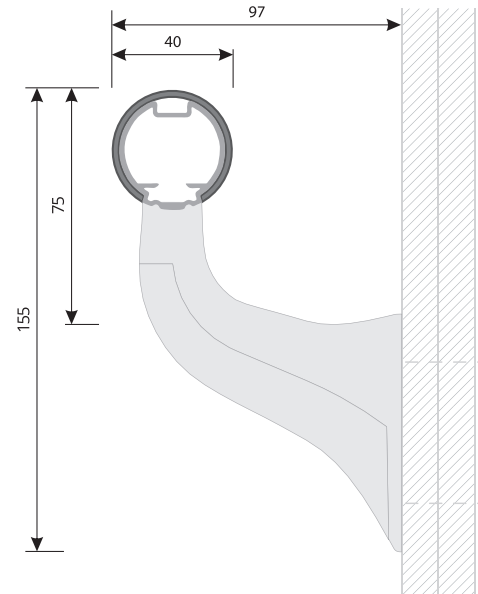

ITEM SPECIFICATIONS

Profile	Shock-absorbing tubular structure with 40 mm diameter in our newly developed PVC FREE POLYCARBONATE profile. Certified European EN 13823 and EN ISO 11925-2 "b-s2,d0" antibacterial certification for Medical usage, with a thickness of 2mm.
Finishing	Smooth surface for a perfect hygienical protection .
Colours	Pigments not containing cadmium and heavy metals, chlorine, phthalates, bromide, halogens and antimony are amalgamated with the main plastic raw substance.
Mounting	Wall mounted, snap up, on an inflexible and seamless extruded aluminum profile; fastened through special stainless steel brackets, distant from each other more than 38 mm, to allow a tight hold on any wall, even on double plasterboard ones. Standard distance from the wall is 55 mm to allow perfect hand-grip.
End caps	Internal and external end caps slotted in the main support to allow perfect fit, in the same plastic material of the profile.
Certifications	European Certification EN 13823 and EN ISO 11925-2 "B-s2,d0" and antibacterial certification for medical usage.



BH.140 BUMPER HANDRAILS

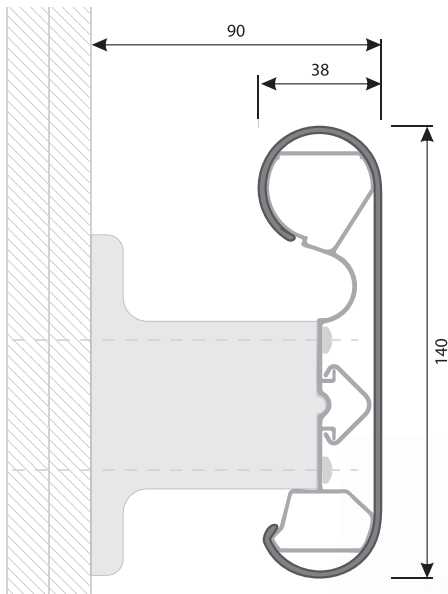

Supply and installation of shock-absorbing bumper handrails newly developed with non-toxic, antibacterial plastic materials of 140 mm maximum height .

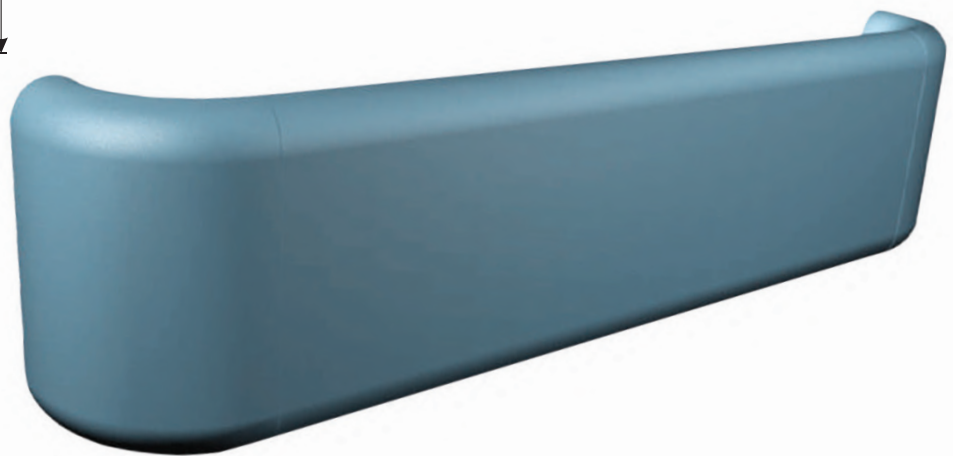

ITEM SPECIFICATIONS

Profile	Shock absorbing and not exceeding (140 – 170) mm, in our newly developed PVC FREE POLYCARBONATE profile. Certified European EN 13823 and EN ISO 11925-2 "b-s2,d0" antibacterial certification for Medical usage, with a thickness of 2mm.
Finishing	A matte finish with FINE embossing for a perfect sanitary protection.
Colours	Pigments not containing cadmium and heavy metals, chlorine, phthalates, bromide, halogens and antimony are amalgamated with the main plastic raw substance.
Mounting	Wall mounted, snap up, on an inflexible and seamless extruded aluminum profile; fastened through self-centering double hole offset brackets, distant from each other more than 63 mm, to allow a tight hold on any wall, even on double plasterboard ones. Standard distance from the wall is 52 mm to allow perfect hand-grip.
End caps	Slotted in the main support to allow perfect fit, in the same plastic material of the profile.
Certifications	European Certification EN 13823 and EN ISO 11925-2 "B-s2,d0" and antibacterial certification for medical usage.

BH.170 BUMPER HANDRAILS



Supply and installation of shock-absorbing bumper handrails newly developed with non-toxic, antibacterial plastic materials of a 170 mm maximum height.

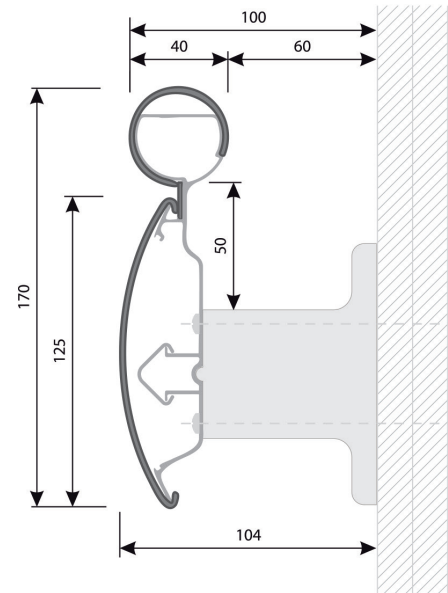
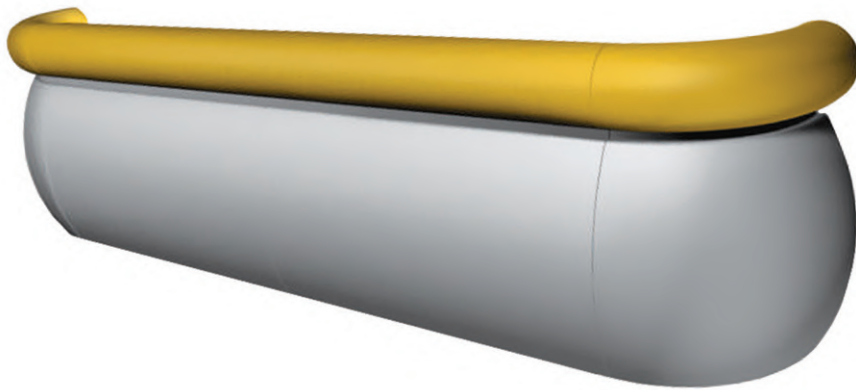

ITEM SPECIFICATIONS

Profile	A tubular structure with a 40 mm diameter and a second shock absorbing 125 mm one in our newly developed PVC FREE POLYCARBONATE profile. Certified European EN 13823 and EN ISO 11925-2 "b-s2,d0" antibacterial certification for Medical usage, with a thickness of 2mm. A 1,5 mm thick coloured insert links the cylindrical profile and the elliptical one.
Finishing	A matte finish with fine embossing for a perfect sanitary protection.
Colours	Pigments not containing cadmium and heavy metals, chlorine, phthalates, bromide, halogens and antimony are amalgamated with the main plastic raw substance.
Mounting	Wall mounted, snap up, on an inflexible and seamless extruded aluminum profile; fastened through offset brackets with self-centering double hole, distant from each other more than 63 mm, to allow a tight hold on any wall, even on double plasterboard ones. Standard distance from the wall is 60 mm to allow suitable hand-grip.
End caps	Internal and external ones slotted in the main support to allow perfect fit, using the same plastic material of the profile.
Certifications	European Certification EN 13823 and EN ISO 11925-2 "B-s2,d0" and antibacterial certification for medical usage.

HC.250 CRASH RAILS

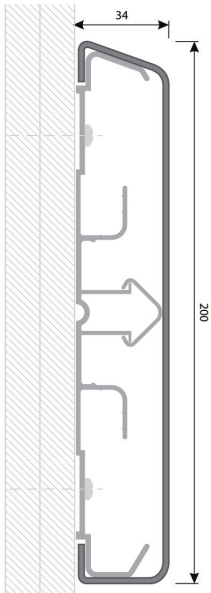

Supply and installation of crash rails produced in an alveolar elastomer structure suitable for hard impacts.



ITEM SPECIFICATIONS

Profile	250 mm high and 9 mm thick structure in black elastomer ideal for hard impacts.
End caps	Zinc-plated steel end caps, to protect the rubber profile from lateral crashes.

SK.100 SKIRTINGS



Supply and installation of a 100 mm high antibacterial, non-toxic and wall sit-on skirting.

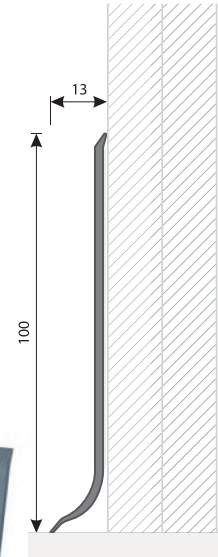
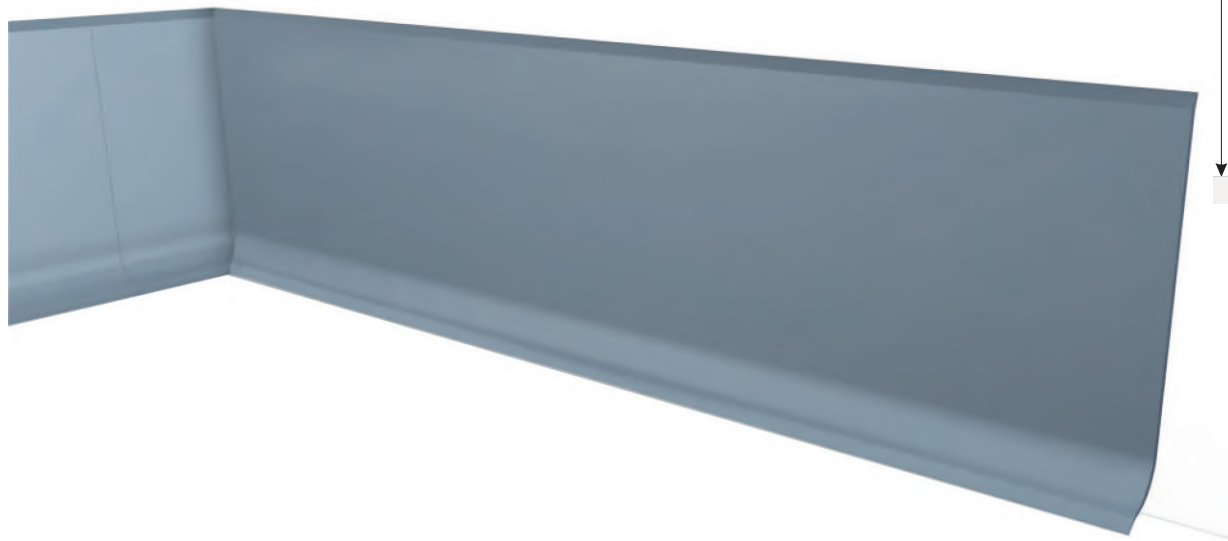

ITEM SPECIFICATIONS

Profile	100 mm high shock-absorbing extruded structure in our newly developed PVC FREE POLYCARBONATE profile. Certified European EN 13823 and EN ISO 11925-2 "b-s2,d0" antibacterial certification for Medical usage, with a thickness of 2mm. Internal and external angular molded corners, in the same shock-absorbing PVC FREE POLYCARBONATE material.
Finishing	Fine embossing for a perfect sanitary protection.
Colours	Pigments not containing cadmium and heavy metals, chlorine, phthalates, bromide, halogens and antimony are amalgamated with the main plastic raw substance.
Mounting	Wall mounted with suitable glue for tight seal.
Certifications	European Certification EN 13823 and EN ISO 11925-2 "B-s2,d0" and antibacterial certification for medical usage.



SH WALL COVERINGS

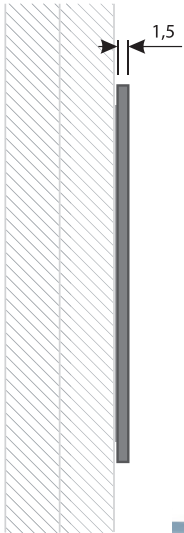

Supply and installation of non-toxic and antibacterial wall covering sheets.

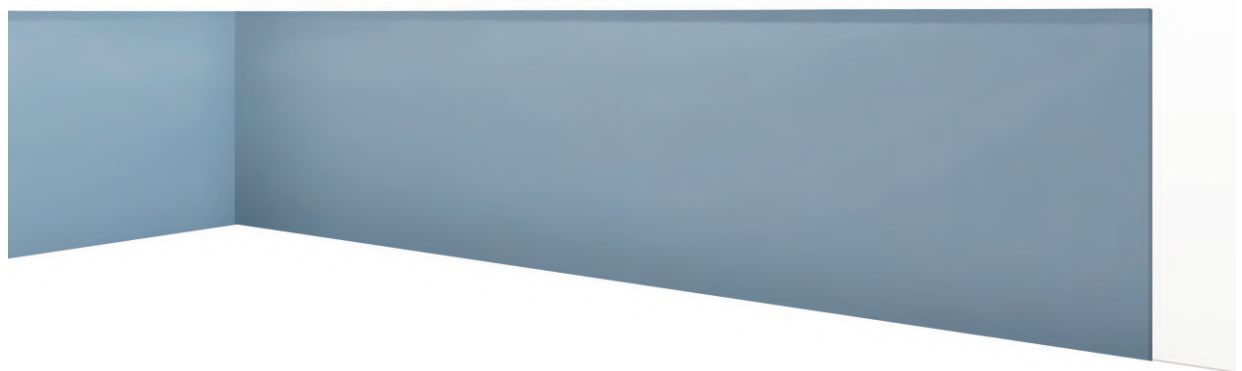

ITEM SPECIFICATIONS

Profile	Shockproof wall covering sheets in our newly developed PVC FREE POLYCARBONATE. profile. Certified European EN 13823 and EN ISO 11925-2 "b-s2,d0" antibacterial certification for Medical usage, with a thickness of 1.5 mm. The sheets are joint together by using capping profiles which can be placed horizontally or vertically, all made in the same PVC FREE POLYCARBONATE material.
Finishing	Fine embossing for a perfect sanitary protection.
Colours	Pigments not containing cadmium and heavy metals, chlorine, phthalates, bromide, halogens and antimony are amalgamated with the main plastic raw substance.
Mounting	Wall mounted with suitable glue for tight seal.
Certifications	European Certification EN 13823 and EN ISO 11925-2 "B-s2,d0" and antibacterial certification for medical usage.

DH PROTECTION FOR DOOR HANDLES

Supplying and installation shockproof, antibacterial, PVC-free, non-toxic plastic, semicircular contoured sheets designed to protect the door handle area.

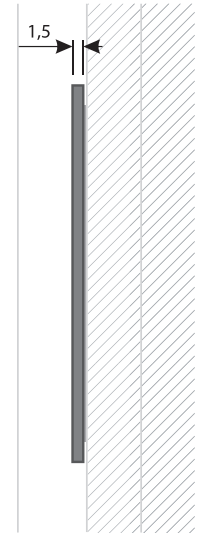
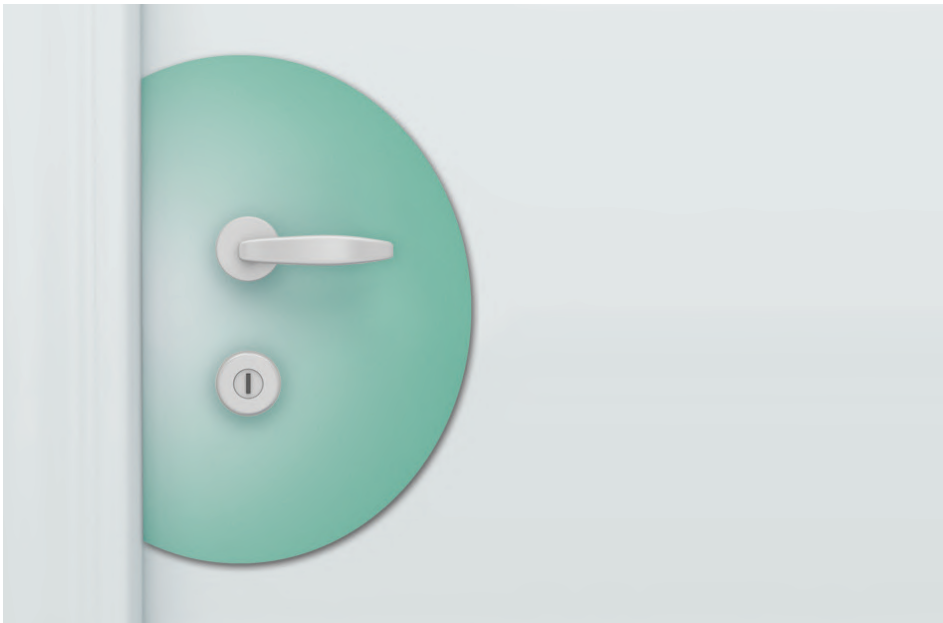

ITEM SPECIFICATIONS

Profile	Shockproof plastic handle covering sheets in our newly developed PVC FREE POLYCARBONATE profile. Certified European EN 13823 and EN ISO 11925-2 "b-s2,d0" antibacterial certification for Medical usage, with a thickness of 1,5 mm.
Finishing	Fine embossing for a perfect sanitary protection.
Colours	Pigments not containing cadmium and heavy metals, chlorine, phthalates, bromide, halogens and antimony are amalgamated with the main plastic raw substance.
Mounting	Applied onto the door panel with a suitable glue for tight seal.
Certifications	European Certification EN 13823 and EN ISO 11925-2 "B-s2,d0" and antibacterial certification for medical usage.

DC DOOR COVERINGS

Supplying and installation shockproof, antibacterial, PVC-free, non-toxic plastic, sheets designed to protect the door panels.

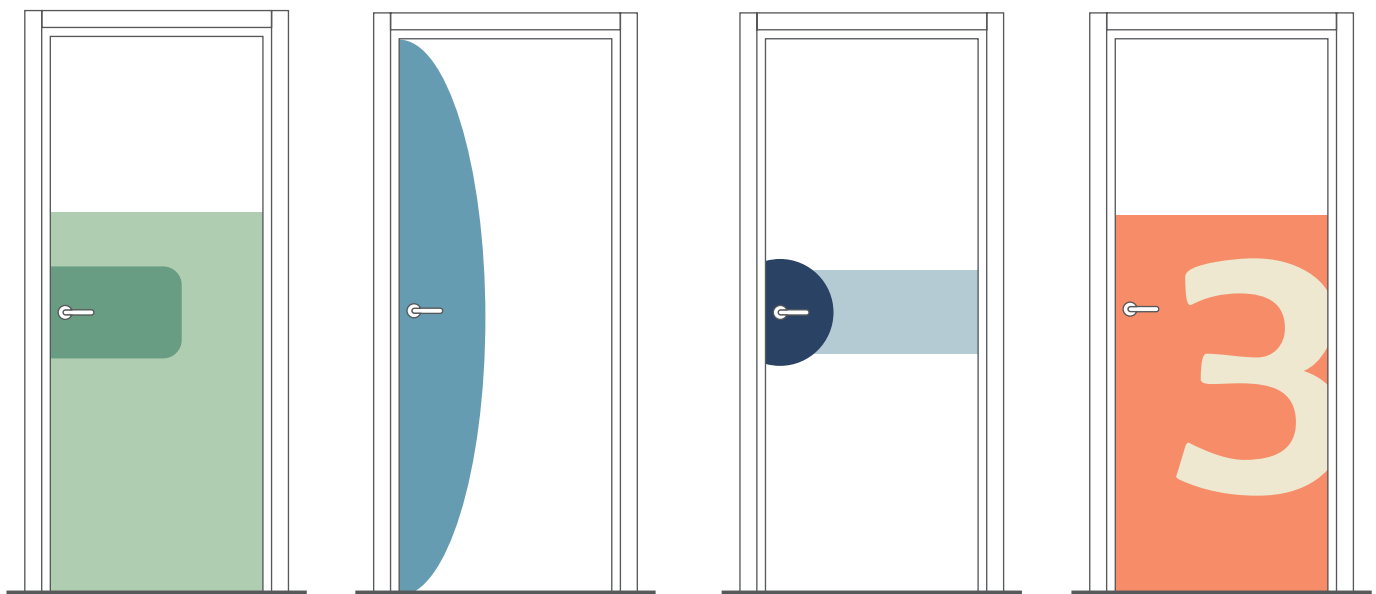

ITEM SPECIFICATIONS

Profile	Shockproof plastic door covering sheets in our newly developed PVC FREE POLYCARBONATE profile. Certified European EN 13823 and EN ISO 11925-2 "b-s2,d0" antibacterial certification for Medical usage, with a thickness of 1,5 mm.
Finishing	Fine embossing for a perfect sanitary protection.
Colours	Pigments not containing cadmium and heavy metals, chlorine, phthalates, bromide, halogens and antimony are amalgamated with the main plastic raw substance.
Mounting	Door mounted with suitable glue for tight seal.
Certifications	European Certification EN 13823 and EN ISO 11925-2 "B-s2,d0" and antibacterial certification for medical usage.
Customization	Available upon request customization of the door coverings. Upon request it is also possible to cover partially or completely the door frame.

PHOTOGALLERY

BH.140 - P.200



BH.140 - SH



BH.170

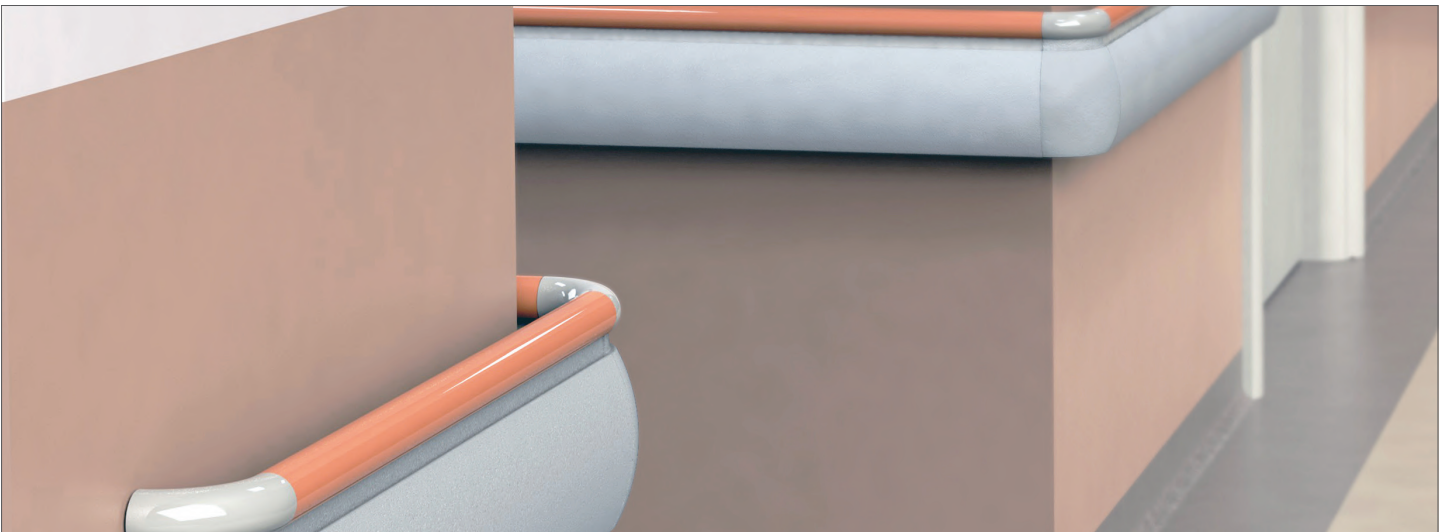

HL.40



SH

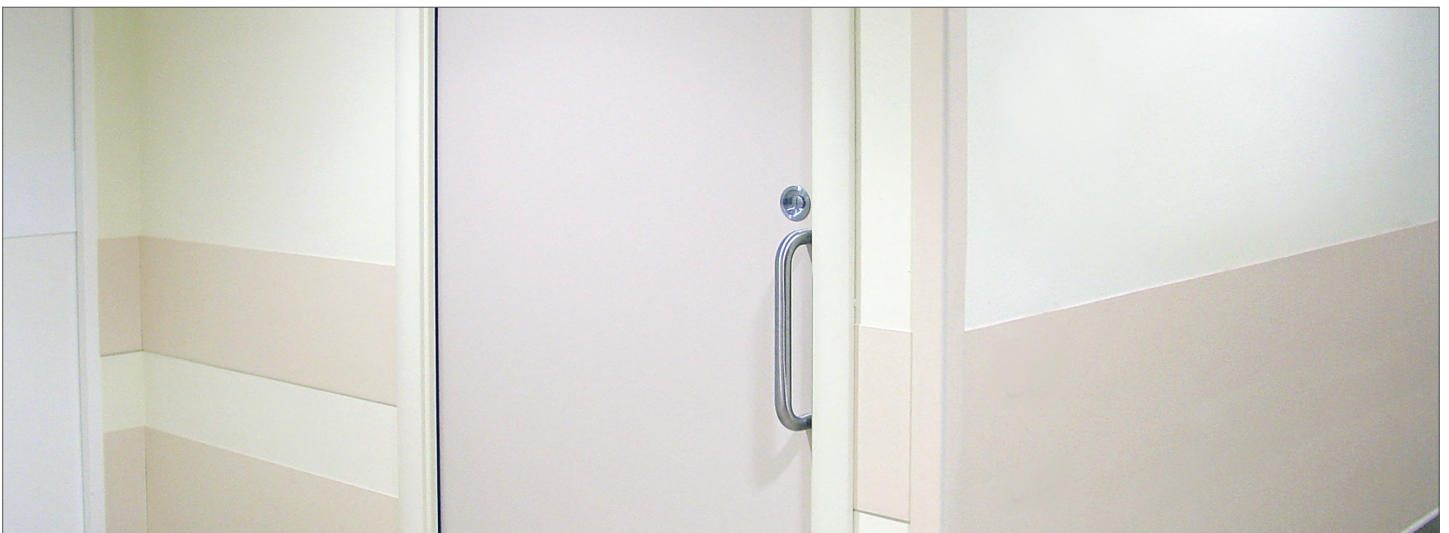

SK.100



COLOURS FINISHING PROFILES

Standard colour for corners, bumpers, handrails, crash rails and skirtings, SH, DH and DC.



916 (FM-01)

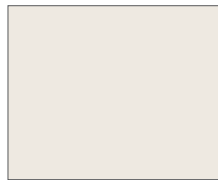

910 (FM-02)

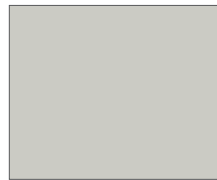

735 (FM-12)



115 (FM-03)



1205 (FM-19)



619 (FM-14)

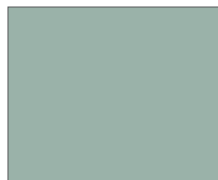

627 (FM-04)



737 (FM-10)

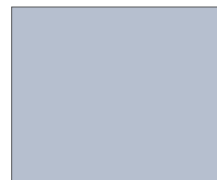

524/1 (FM-06)



514 (FM-15)

The following colours are on request for SH, DH and DC. These are standard instead for all the other products.

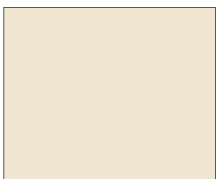

901 (FM-13)

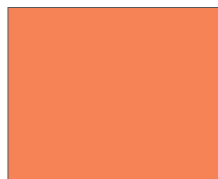

203 (FM-18)



502 (FM-16)

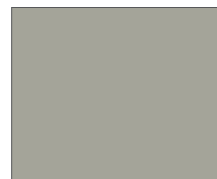

704 (FM-09)



633 (FM-05)



524/3 (FM-11)



510 (FM-08)



524/2 (FM-07)

The colours in this catalogue are for guidance only, please refer to our colour swatch.



RECOGNIZED CERTIFICATIONS

High reliability with the whole supplying network, constant personnel training, focused fine-tuning of the production processes, steady product improvements and commercial dependability have allowed us to obtain in a very short time the following broadly recognized quality system certifications:

- ISO 9001:2008
QUALITY MANAGEMENT SYSTEMS
- EN ISO 13485:2012
MEDICAL DEVICES QUALITY MANAGEMENT SYSTEMS



ISO 9001:2008
N° 9120.LMMD



REG. N. IT-79003



EN ISO 13485:2012
N° 9124.LMM2



THE INTERNATIONAL CERTIFICATION NETWORK

CERTIFICATE

IQNet and its partner

CISQ/IMQ-CSQ

hereby certify that the organization

LM MEDICAL DIVISION SRL

VIA BORNICO SNC - FRAZ. S. PANCRAZIO - 25036 PALAZZOLO SULL'OGGIO (BS)

for the following field of activities

Design, manufacturing of electro medical equipment and furniture

Refer to quality manual for details of applications to ISO 9001:2008 requirements

has implemented and maintains a

Quality Management System

which fulfills the requirements of the following standard

ISO 9001:2008

Issued on: 2013 - 06 - 13

Expiry date: 2014 - 06 - 26

Registration Number: IT - 79003



Michael Drechsel

President of IQNET



Ing. Claudio Provetti

President of CISQ

IQNet Partners*:
AENOR Spain AFNOR Certification France AIB-Vincotte International Belgium ANCE-SIGE Mexico APCER Portugal CCC Cyprus
CISQ Italy CQC China CQM China CSQ Czech Republic Cro Cert Croatia DQS Holding GmbH Germany DS Denmark
FCAV Brazil FONDONORMA Venezuela ICONTEC Colombia IMNC Mexico INNORPI Tunisia
Inspecta Certification Finland IRAM Argentina IQA Japan KFQ Korea MIRTEC Greece MSZT Hungary Nemko AS Norway
NSAI Ireland PCBQ Poland Quality Austria Austria RR Russia SII Israel SIQ Slovenia SIRIM QAS International Malaysia
SQS Switzerland SRAC Romania TEST St Petersburg Russia TSE Turkey YUQS Serbia
IQNet is represented in the USA by: AFNOR Certification, CSQ, DQS Holding GmbH and NSAI Inc.
* The list of IQNet partners is valid at the time of issue of this certificate. Updated information is available under www.iqnet-certification.com